

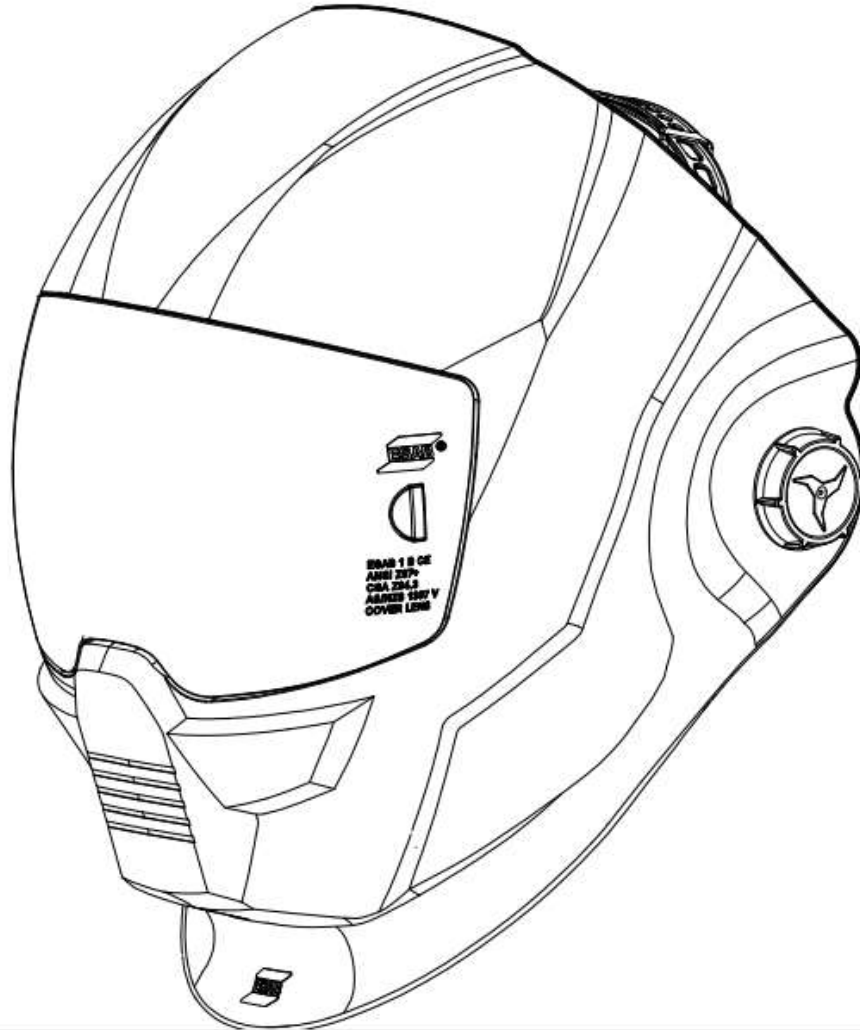

Sentinel A-60



Auto Darkening Welding Helmet

USER MANUAL

PLEASE READ AND UNDERSTAND ALL INSTRUCTION BEFORE USE.
RETAIN THIS MANUAL FOR FUTURE REFERENCE.

Complete User Manual at:

Manual Number: 0-5659
Revision Date: 03-16-2023
Revision Number: B
Language: ENGLISH



SAFETY

Meaning of symbols

As used throughout this manual: Means Attention! Be Alert!



DANGER!

Means immediate hazards which, if not avoided, will result in immediate, serious personal injury or loss of life.



WARNING!

Means potential hazards which could result in personal injury or loss of life.



CAUTION!

Means hazards which could result in minor personal injury.



WARNING!

Before use, read and understand the instruction manual and follow all labels, employer's safety practices and Safety Data Sheets (SDSs).



Safety precautions



WARNING!

Only qualified personnel should install, operate, maintain, and repair this unit.

The Auto-Darkening welding helmet comes assembled. But before it can be used, it must be adjusted to fit the user properly. Check battery surfaces and contacts and clean them if necessary. Verify if the battery is in good condition and installed properly. Set up for delay time, sensitivity, and shade number for your application.

The helmet should be stored in a cool, dry, and dark place. Remove the battery before long-time storage.

1. This Auto-Darkening welding helmet is not suitable for laser welding.
 2. Never place this helmet and Auto-Darkening filter on a hot surface.
 3. Never open or tamper with the Auto-Darkening filter. There are no user-serviceable parts inside.
 4. This Auto-Darkening welding helmet will not protect against severe impact hazards.
 5. This helmet will not protect against explosive devices or corrosive liquids.
 6. Do not make any modifications to either the filter or helmet, unless specified in this manual.
 7. Do not use replacement parts other than those specified in this manual.
 8. Unauthorized modifications and replacement parts will void the warranty and expose the operator to personal injury.
 9. Should this helmet not darken upon striking an arc, stop welding immediately and contact ESAB.
 10. Do not immerse the Auto-Darkening filter in water.
 11. Do not use any solvents on the Auto-Darkening filter screen or helmet components.
-

12. Protect the auto-darkening (ADF) filter from contact with liquid and dirt.
 - Clean the (ADF) surface regularly by using clean water and a lint-free or microfiber cloth; do not use strong cleaning solutions. Always keep the sensors and solar cells clean using a clean lint-free tissue or microfiber cloth.
 - Regularly replace a cracked/scratched/pitted front cover lens. Avoid setting the helmet down directly on the cover lens to avoid premature damage to the cover lens.
 - The materials which may come into contact with the wearer's skin can cause allergic reactions in some circumstances.
 - The Auto-Darkening filter shall only be used in conjunction with the inner cover lens.



ARC RAYS - Can injure eyes and burn skin

The arc, like the sun, emits ultraviolet (UV) and other radiation and can injure skin and eyes. Hot metal can cause burns. Training in the proper use of the processes and equipment is essential to prevent accidents. Therefore:

1. Wear a welding helmet fitted with a proper shade of filter to protect your face and eyes when welding or watching.
2. Wear approved safety glasses with side shields under your helmet.
3. Before welding, adjust the auto-darkening filter (ADF) lens sensitivity to meet the application. Warn bystanders not to watch the arc and not to expose themselves to the rays of the electric-arc or hot metal.
4. Wear protective clothing made from durable, flame-resistant material. A flameproof apron may also be desirable as protection against radiated heat and sparks.
5. Protect other personnel from arc rays and hot sparks with a suitable non-flammable partition or curtains.
6. Use goggles or face shield over safety glasses when chipping slag or grinding. Chipped slag may be hot and can fly far. Bystanders should also wear goggles over safety glasses.
7. The ADF uses a solar panel which acts as an automatic switch-off/on function to increase battery life. When the solar panel is exposed to low ambient light conditions (less than 11 lux or a single candlepower) over a period of approximately 20 seconds, the ADF switches off automatically. To switch the ADF back on, the solar cells must be exposed to light in excess of 10 lux for a period of up to 15 seconds. For ADFs with a digital display, ensure the ADF is active by pressing any button on the ADF to activate the LED screen.



NOISE - Excessive noise can damage hearing

Protect your ears. Wear approved ear protection if noise level is high.



FUMES AND GASES

Fumes and gases can cause discomfort or harm, particularly in confined spaces. Shielding gases can cause asphyxiation. Therefore:

1. Keep your head out of the fumes. Do not breathe the fumes and gases.
 2. Always provide adequate ventilation in the work area by natural or mechanical means. Do not weld, cut or gouge on materials such as galvanized steel, stainless steel, copper, zinc, lead beryllium or cadmium unless positive mechanical ventilation is provided. Do not breathe fumes from these materials.
 3. Do not operate near degreasing and spraying operations. The heat or arc can react with chlorinated hydrocarbon vapors to form phosgene, a highly toxic gas and other irritant gases.
-

4. If you develop momentary eye, nose or throat irritation while operating, this is an indication that ventilation is not adequate. Stop work and take necessary steps to improve ventilation in the work area. Do not continue to operate if physical discomfort persists.
5. Refer to ANSI/ASC Standard Z49.1 for specific ventilation recommendations.



FIRES AND EXPLOSIONS

Heat from flames and arcs can start fires. Hot slag or sparks can also cause fires and explosions. Therefore:

1. Protect yourself and others from flying sparks and hot metal.
2. Remove all combustible materials well away from the work area or cover the materials with a protective non-flammable covering. Combustible materials include wood, cloth, sawdust, liquid and gas fuels, solvents, paints coatings, paper, etc.
3. Hot sparks or hot metal can fall through cracks or crevices in floors or wall openings and cause a hidden smoldering fire or fires on the floor below. Make certain that such openings are protected from hot sparks and metal.
4. Do not weld, cut or perform other hot work until the work piece has been completely cleaned so that there are no substances on the work piece which might produce flammable or toxic vapors. Do not do hot work on closed containers, they may explode.
5. Have fire extinguishing equipment handy for instant use, such as a garden hose, water pail, sand bucket, or portable fire extinguisher. Be sure you are trained in its use.
6. Do not use equipment beyond its ratings. For example, an overloaded welding cable can overheat and create a fire hazard.
7. After completing operations, inspect the work area to make certain there are no hot sparks or hot metal which could cause a fire later. Use fire watchers when necessary.



CAUTION!

ADDITIONAL SAFETY INFORMATION

For more information on safe practices for electric arc welding and cutting equipment, ask your supplier for a copy of "Precautions and Safe Practices for Arc Welding, Cutting and Gouging", Form 52-529.

The following publications are recommended:

- ANSI/ASC Z49.1 - "Safety in Welding and Cutting"
- AWS C5.5 - "Recommended Practices for Gas Tungsten Arc Welding"
- AWS C5.6 - "Recommended Practices for Gas Metal Arc welding"
- AWS SP - "Safe practices" - Reprint, Welding Handbook
- ANSI/AWS F4.1 - "Recommended Safe Practices for Welding and Cutting of Containers That Have Held Hazardous Substances"
- OSHA 29 CFR 1910 - "Safety and health standards"
- CSA W117.2 - "Code for safety in welding and cutting"
- NFPA Standard 51B, "Fire Prevention During Welding, Cutting, and Other Hot Work"
- CGA Standard P-1, "Precautions for Safe Handling of Compressed Gases in Cylinders"
- ANSI Z87.1, "Occupational and Educational Personal Eye and Face Protection Devices"

ESAB has an assortment of welding accessories and personal protection equipment for purchase. For ordering information contact your local ESAB dealer or visit us on our website.

**Dispose of electronic equipment at the recycling facility!**

In observance of European Directive 2002/96/EC on Waste Electrical and Electronic Equipment and its implementation in accordance with national law, electrical and/or electronic equipment that has reached the end of its life must be disposed of at a recycling facility. As the person responsible for the equipment, it is your responsibility to obtain information on approved collection stations.

For further information, contact the nearest ESAB dealer.

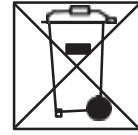

California Proposition 65 warning

**WARNING!**

Welding or cutting equipment produces fumes or gases which contain chemicals known in the State of California to cause birth defects and, in some cases, cancer. (California Health & Safety Code Section 25249.5 et seq.)

**WARNING!**

This product can expose you to chemicals including lead, which are known to the state of California to cause cancer and birth defects or other reproductive harm. Wash hands after use.

For more information, go to www.P65Warnings.ca.gov.

TECHNICAL DATA

Weight	644 gm (1.42 lbs)
Optical Class	1 / 1 / 1 / 1
ADF Dimension (l×h)	132×121 mm (5.20" × 4.76")
Viewing Area	118×71mm (4.65"×2.8")
Arc Sensor	4
Light State	DIN 3
Grind State	DIN 3
Welding Mode	Shade No. from 5-8/9-13
Shade Control	Internal, Variable Shade, Digital button Control
Power On/Off	Automatic On / Off
Sensitivity Control	Low — High, Digital button Control
UV/IR Protection	Up to Shade DIN16 at all times
Power Supply	Solar cell. Battery replaceable; 2 × CR2450 lithium battery
Switching Time	1/25,000 s. from Light to Dark
Grinding Mode	Yes via external push button or internal mode selection
Delay (Dark to Light)	0.1 ~ 0.9 s Digital button Control
Low Amperage TIG Rated	≥ 3 amps
Operating Temperature	-10 °C – 65 °C (14 °F – 149 °F)
Storing Temperature	-20 °C – 85°C (-4 °F –185°F)
Certifications	CE (EN166 ; EN175 ; EN379), ISO 16321 V1 +TIG, UKCA ANSI Z87.1, CSA Z94.3, AS/NZS 1338.1

Guide for shade numbers				
Operation	Electrode size 1/32 in. (mm)	Arc current (A)	Minimum protective shade	Suggested ⁽¹⁾ shade No. (comfort)
Shielded metal arc welding	Less than 3 (2.5)	Less than 60	7	—
	3-5 (2.5–4)	60-160	8	10
	5-8 (4–6.4)	160-250	10	12
	More than 8 (6.4)	250-550	11	14
Gas metal arc welding and flux Cored arc welding		Less than 60	7	—
		60-160	10	11
		160-250	10	12
		250-500	10	14
Gas tungsten arc welding		Less than 50	8	10
		50-150	8	12
		150-500	10	14
Air carbon	(Light)	Less than	10	12
Arc cutting	(Heavy)	500	11	14
Plasma arc welding		Less than 20	6	6 to 8
		20-100	8	10
		100-400	10	12
		400-800	11	14
Plasma arc cutting	(Light) ⁽²⁾	Less than	8	8
	(Medium) ⁽²⁾	300	9	12
	(Heavy) ⁽²⁾	300-400	10	14
Torch brazing		—	—	3 to 4
Torch soldering		—	—	2
Carbon arc welding		—	—	14
Plate thickness				
	in.	mm		
Gas welding				
Light	Under 1/8	Under 3.2		4 or 5
Medium	1/8 to 1/2	3.2 to 12.7		5 or 6
Heavy	Over 1/2	Over 12.7		6 or 8
Oxygen cutting				
Light	Under 1	Under 25		3 or 4
Medium	1 to 6	25 to 150		4 or 5
Heavy	Over 6	Over 150		5 or 6

(1) As a rule of thumb, start with a shade that is too dark, then go to a lighter shade which gives a sufficient view of the weld zone without going below the minimum. In oxyfuel gas welding or cutting where the torch produces a high yellow light, it is desirable to use a filter lens that absorbs the yellow or sodium line the visible light of the (spectrum) operation.

(2) These values apply where the actual arc is seen. Experience has shown that lighter filters may be used when the arc is hidden by the workpiece.

Data from ANSI Z49.1-2005

OPERATING INSTRUCTIONS

BATTERY INSTALLATION

1. Use the included screwdriver, or other similar-sized screwdriver to remove the retention screw
2. Slide the battery cover out of the external control case and install the battery properly (“+ side facing UP”), slide the cover back into position after battery installation.
3. Insert the screw and tighten.

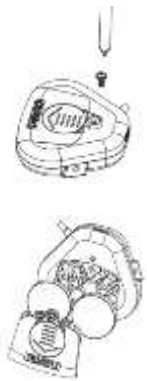

Warning: Keep the battery away from children!

LED DISPLAY

1. Press any button on the Auto-Darken filter (ADF) control panel or press the external “Grind” button to activate the LED display.
2. The LED display will automatically turn off after 10 seconds if no buttons are pressed. Symbols on the LED display will flash during adjustment and will stop flashing after 8 seconds if there is no adjustment. The current settings will remain active.



BATTERY INDICATOR

This ADF is powered by a solar cell and (2) CR2450 lithium batteries.

The “” symbol shows the current state of the battery.

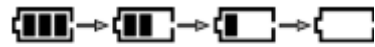
The battery indicator identifies 4 levels of current capacity.



When the indicator symbol shows “”, and the “ LED” LED is continuously illuminated “red”, the batteries should be exchanged for new ones.

SELECTING GRIND MODE

Option 1: Press the “” button on the ADF to switch to grind mode.

Option 2:



1. Pressing the “GRIND” button on the upper right external side of the helmet shell for 2 seconds, ADF will switch to grind mode.
2. Press the “GRIND” button for 2 seconds again, and it will return to the previous welding shade setting.



During “Grind” mode, the lens shade is fixed shade 3 and **cannot** be adjusted. “Grind” indicator is an “Amber” LED on the ADF control panel, and will flash when Grind Mode is active.

Warning: Do not weld while using Grind mode!



VARIABLE SHADE CONTROL

1. Press the “” button on the ADF control panel. This will switch the shade mode between shade banks 5-9, 9-13, or Grind. Select the shade range between Shade 5-9 or Shade 9-13
2. Press the “SET” button to select the shade, Press “” to increase the shade number; Press “” to reduce the shade number. Select the proper shade number for your welding or cutting process by referring to the “Shade Guide Table” above.

SENSITIVITY CONTROL

Sensitivity can be adjusted only while using the welding mode.

Select your desired shade.

Press the “set” button to select “sensitivity”, The “**SENSI.**” symbol will flash. Press “” to increase the sensitivity; Press “” to reduce the sensitivity. This allows the ADF to become more or less sensitive to arc light, for different welding processes.



SENS1 indicates sensitivity is at low. Low sensitivity is Suitable for using outdoors (excessive ambient/environmental light conditions) and with higher amperage SMAW and FCAW operations.





SENS2 indicates sensitivity is at high. High sensitivity is Suitable for low amperage welding with GTAW or GMAW operations.

Under normal welding conditions, a higher sensitivity setting is recommended.

DELAY CONTROL

Delay can be adjusted only while using welding mode.
Select your desired shade range.

Press the “set” button to select “Delay”, The “**DELAY**” symbol will flash. Press “” to increase the Delay; Press “” to reduce the Delay. This setting adjusts the amount of time the lens takes to lighten after welding. There are 5 settings to adjust delay, with a delay range of 0.1~0.9 seconds.









DELAY Indicates the longest delay setting. The longest time is about 0.9 seconds depending upon welding point temperature and shade set. This setting is ideal for welding at high amperage where there is an afterglow from the weld.







DELAY Indicates the shortest delay setting. The shortest time is about 0.1second depending upon welding point temperature and shade set. This setting is ideal for tack welding or production welding with short welds.

MEMORY SETTING

The Sentinel A-60 ADF can save the setting parameters into a memory setting. Users can recall a memory at any time they need. The system can save up to 9 sets of parameters. Take memory setting 1 as an example:

1. Press the “” button on the ADF control panel, select memory set to position “1” by pressing “” or “”; the memory number symbol “” will flash.
2. Set shade, sensitivity, and delay according to the set steps above.
3. After finishing all settings, the ADF will store the parameters automatically after 10s if there is no operation. The memory position will be position “1”.
4. MEMORY 2 to MEMORY 9 can be set the same way. Users can call out the MEMORY setting by selecting the memory position via short press “MEMORY” first and then choosing the desired memory number via “” and “”. The ADF will change to the selected setting from memory automatically after 10 seconds.

LOCK SHADE SETTING

1. Press “” and hold for 2 seconds, the ADF will change to “Lock Shade” mode. This mode allows the ADF to remain activated to the chosen welding shade setting while it is in “Lock” mode. The ADF will not return to a light state.
2. You can select the shade number from 5-13 via pressing “” and “”
3. Press “” and hold for 2 seconds and the ADF will revert to standard operating mode.

Magnifying lens installation

1. Install the magnifying lens into the magnifying lens frame
2. Install the magnifying lens frame into the Auto-Darkening filter by sliding it down into the magnifier frame retention bracket as shown in the below picture

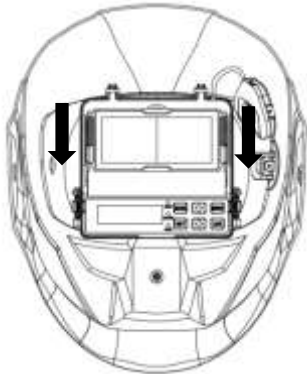

ADJUSTING THE FIT OF THE HELMET

The overall circumference of the headband can be made larger or smaller by rotating the knob on the back of the headband. (See adjustment “1” in the picture below). This can be done while wearing the helmet and allows easy micro-level tension adjustment to keep the helmet firmly on the head without it being too tight.

If the headband is riding too high or too low on your head, adjust the straps which pass over the top of your head. To do this, release the end of the band by pushing the locking pin out of the band's hole. Slide the two portions of the band to a greater or lesser width as required, and push the locking pin through the nearest hole. (See adjustment “4” in the picture below).

ADJUSTING THE DISTANCE BETWEEN THE HELMET AND FACE

1. Press and hold the slider (see adjustment 3 in the picture below) on both sides, to slide the headgear back and forth within the helmet.
2. Ensure the slider is locked back into position and make certain the distance between the lens to both eyes is equal. This avoids issues with uneven ADF darkness.

ADJUSTING VIEW ANGLE POSITION

The tilt adjustment is located on the right side of the helmet. Loosen the right headgear tension knob and adjust the lever forward or back to the desired position (see adjustment 2 in the picture below). Retighten the right headgear tension knob.

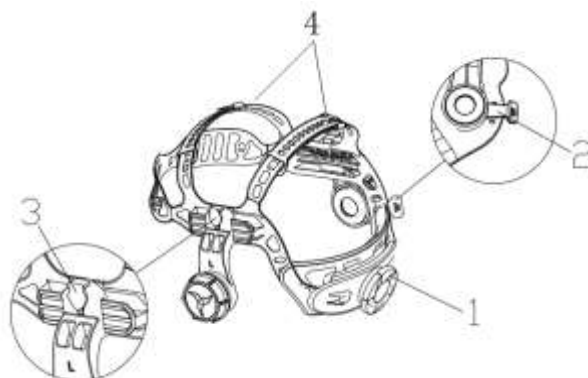

Certification and Control labels

The SENTINEL™ A-60 conforms to PPE Regulation 2016/425/EU, Regulations (EU) 2016 as brought into UK law and amended and harmonized/designated standard EN 166:2001, EN 175:1997 and EN379:2003+A1:2009. Approved body for UK certification: SGS United Kingdom Limited, Rossmore Business Park, Ellesmere Port South Wirral Cheshire, CH65 3EN notified body no. 0120. Notified body for CE Certification: ECS GmbH, Huettfeldstrasse 50 / Obere Bahnstrasse 74, 73430 AALEN / 73431 AALEN GERMANY that provides approval and continual quality system under the control of the European Commission, the German Ministry for Work and the Central Office of the Provinces. The shell and the auto darkening filter are marked accordingly. Classification for eye and face protection is following EN379, EN175, EN166.

We are therefore allowed to use the following marks:



European Conformity mark

EN 175
EN 166
EN 379

ADF Marking Explanation:

3/5-9/9-13 ESAB 1/1/1/1/379 CE UKCA

3 - Light state scale number

5-9 /9-13 -Dark state scale number

ESAB - Manufacture's name

1 - Optical class

1 - Diffusion of light class

1 - Variation in luminous transmittance class

1 - Angle dependence of luminous transmittance class

379 - Number of the standard

16321 ESAB W3/5-9/9-13 V1

16321 - Number of the ISO standard

ESAB - Manufacture's name

3 - Light state scale number

5-9 /9-13 - Dark state scale number

V1 - Angle dependence of luminous transmittance class

Welding Helmet Marking Explanation:

ESAB EN175 B CE UKCA

ESAB -Manufacturer's identification EN175 - Testing standard

B - Resistance against medium energy impact (120m/s)

CE - European conformity

UKCA - UK conformity

Front/Inside Cover Lens Explanation:

ESAB 1 B CE UKCA

ESAB -Manufacturer's identification

1 = optical class

B - Resistance against medium energy impact (120m/s)

CE - European conformity

UKCA - UK conformity

MAINTENANCE

Carefully inspect the welding helmet before each use for worn or damaged parts. Replace any worn or damaged parts only with approved ESAB components as listed in the spare parts list contained in this *User Manual*.

ESAB recommends a use period of 5 years. The duration of use depends on various factors such as use, cleaning, storage and maintenance. Frequent inspections and replacement if helmet is damaged are recommended.

REPLACING THE FRONT COVER LENS

Replace the front cover lens if it becomes scratched or damaged. Press the semicircle lens retention button on the external side adjacent to the external grind mode button (right side as worn), and remove the front cover lens carefully. When replacing with a new front cover lens, make sure to assemble from the side opposite first, and then snap the lens into the lens retention button side. **Please avoid placing your helmet face down when not in use. This helps lengthen the lifespan of the front cover lens.**

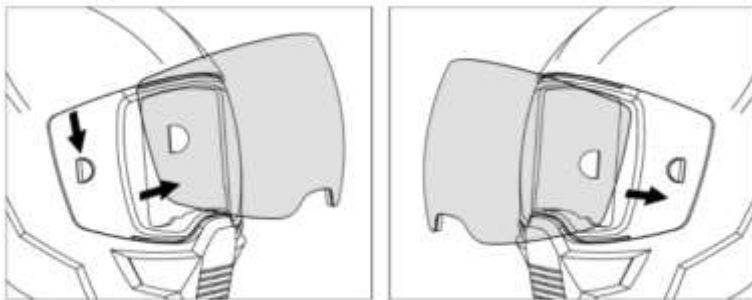

REPLACING THE INSIDE COVER LENS

Replace the inside cover lens if it is damaged.

Lift the lens at the recess below the Auto-Darkening filter. The inside cover lens will flex upward and release from the cartridge.

REPLACING THE AUTO-DARKENING FILTER (ADF)

1. Remove the external "Grind" button's retainer screw, located on the right-side edge of the battery compartment inside the helmet shell and behind the "Grind" button.
2. Push the locks on both sides of the ADF, push the "Grind" button inward by pressing it firmly, then the ADF can be removed from the shell.
3. When installing a new ADF, install the Grind button from inside the shell, press it firmly then put the ADF into the shell and lock the Auto-Darkening filter into place.

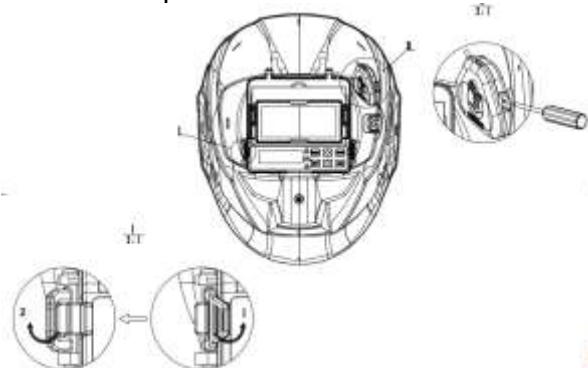

CLEANING

Clean helmet by wiping with a soft, dry cloth. Clean the cartridge surfaces regularly. Do not use strong cleaning solutions.

SPARE PARTS

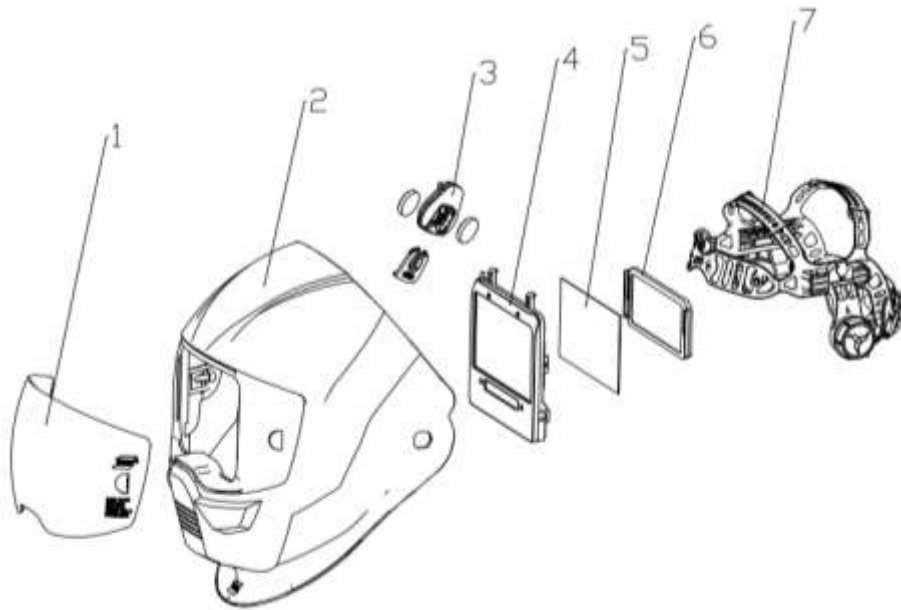

Item ID	Wear and Spare Parts	Part Number
1	A-60 Front Cover Lens Clear	0700 600 880
	A-60 Front Cover Lens Amber	0700 600 881
	A-60 Front Cover Lens Clear HD	0700 600 882
	A-60 Front Cover Lens Amber HD	0700 600 883
2	Sentinel A-60 Helmet Shell	0700 600 863
	Sentinel A-60 Air shell with air duct	0700 600 864
3	Batteries 2*CR2450	Reference
4	Auto-Darkening Filter (excl. batteries)	0700 600 865
5	Inside Cover Lens (121.5 x 74.5mm)	0700 600 866
6	Magnifying Lens Frame (Provided with Magnifying Glass)	N/A
7	Headgear Assembly for A-60 (Including sweatbands)	0700 600 867
	Headgear Assembly for A-60 Air (including sweatbands)	0700 600 868
	Front Sweat Band (forehead) with ESAB Logo	0700 600 869
	Magnifying Glass +1.0 Diopter (For A-60 Air)	0700 600 872
	Magnifying Glass +1.5 Diopter (For A-60 Air)	0700 600 873
	Magnifying Glass +2.0 Diopter (For A-60 Air)	0700 600 874
	Magnifying Glass +2.5 Diopter (For A-60 Air)	0700 600 875

TROUBLESHOOTING

Irregular Darkening or Dimming

Check to ensure the fore/aft adjustment to the headgear is set to the same position on both sides of the headgear. This ensures the correct and equal distance of the ADF to the user's eyes.

The ADF does not darken or flicker

1. If the front cover lens is soiled or damaged (Change the cover lens).
2. Sensors are soiled (Clean the surface of the sensor).
3. Welding current is too low (Adjust the sensitivity level higher).
4. Check battery and verify they are in good condition and installed properly. Also, check battery surfaces and contacts and clean if necessary.

Please refer to the "**BATTERY INSTALLATION**" portion of this manual.

Slow response

The operating temperature is too low (Do not use at temperatures below -5 °C or 23 °F).

Poor vision

1. Front / inside cover lens and/or the filter is soiled (Change lens).
2. There is insufficient ambient light.
3. Shade number is incorrectly set (Reset the shade number).
4. Ensure the protective film has been removed from the outer cover lens before first use.

Welding helmet slips

Headgear is not properly adjusted (readjust the headgear) or is damaged (replace the headgear).



A WORLD OF PRODUCTS AND SOLUTIONS.



ESAB AB
Lindholmsallén 9
Box 8004
402 77 Gothenburg
Sweden
Phone +46 (0) 31 50 90 00

ESAB Corporation
2800 Airport Road
Denton, TX 76207
USA
Phone +1 800 378 8123

ESAB Holdings Ltd
322 High Holborn
WC1V 7PB
London, Great Britain
Phone +44 (0) 1992 768515

For contact information visit esab.com

manuals.esab.com

